

Louvre Doors

Description

For intake or extract air, the louvre doors are available in 50mm pitch or 75mm pitch blades and in single or double leaf. Either with flanged frame or recessed frame, the louvre doors are robustly manufactured with optional threshold details. Door furniture and ironmongery can generally be provided to suit specific needs and generally include optional mortice locks, door stays, panic push bars and handles.

Construction

From extruded aluminium sections, frame 5.0mm thick, blades 1.6mm thick. All frames are fully welded construction fitted as standard with rear galvanised steel bird mesh screen. Euro profile cylinder mortice lock and stainless steel hinges with ball bearing washers are fitted as standard and plated brass shoot bolts are fitted as standard to one leaf of double doors.

Size and Weight

Generally to suit individual door openings or can be incorporated within large louvre sections.
Average weight: 20.0kg/m².
Average free area: 40%.

Rain Defence

The 50mm & 75mm louvre systems have been tested by BSRIA to European standard EN13030:2002 and achieve Class C - (80 - 94.9 % effectiveness).

Airflow Performance

Tested to EN13030:2002 the following aerodynamic coefficient is achieved:
50mm Intake ~ 0.253.
75mm Intake ~ 0.258.

Options

Matt black rear blanking panels
Insulated blanking panels (Thermal & Acoustic)
Guards: Insect screen (Fixed or Removable)
Panic bars, door stays, master keying, keypad locks, door closers, etc.

Product Specification

STATE QUANTITY, THE PRODUCT CODING AND THE SIZE
WIDTH X HEIGHT
e.g. 1 Qty. D7WC1FM+0C 1800 x 2100



Product Type	Blade Pitch	Frame Style	Threshold	Mesh Options
S Single Leaf Door	7W 75 mm	A1 Flanged Frame	F Flat Plate Threshold	M Bird Mesh
D Double Leaf Door	5W 50 mm	C1 Recessed Frame	A Flanged Threshold	I Insect Mesh
			C 38 mm Channel	0 None
			0 None	



Fixings	Finish
0 None	D Mill Finish
1 Flange Holes	C PPC BS / RAL Colour
2 Rear Fixing Lugs	

Double Leaf Louvre Doors

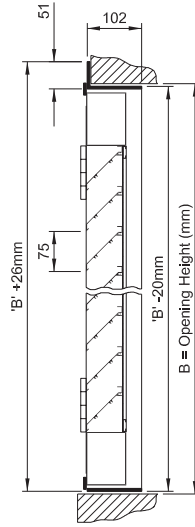
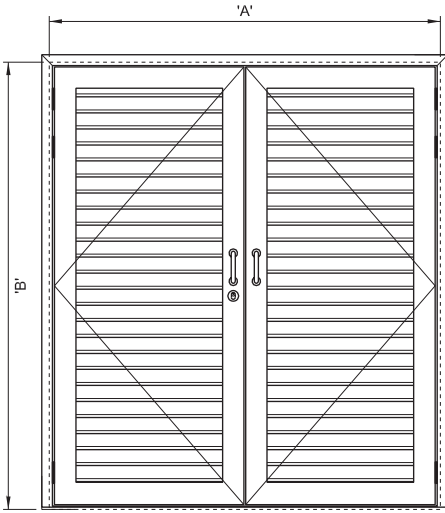

D7WA1FM

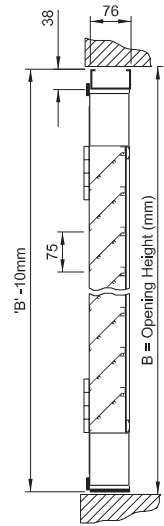

D7WC1FM

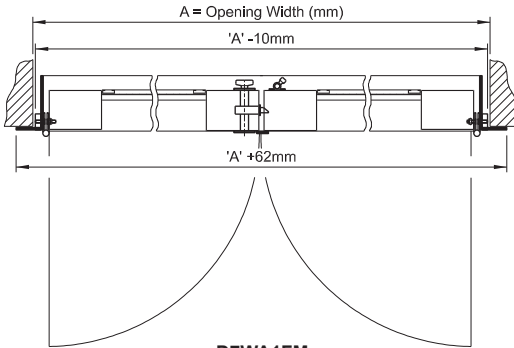

D7WA1FM

Threshold Options

Threshold 'F'
5.0mm thick flat threshold plate can be fitted to either frame style A1 or C1

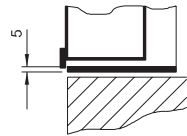

Threshold 'A'
51mm flanged threshold matching frame style A1

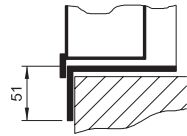

Threshold 'C'
38mm channel threshold can be fitted to either frame style A1 or C1

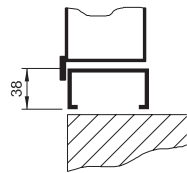

Threshold 'O'
No threshold required. Frame is supplied with removable transit bar

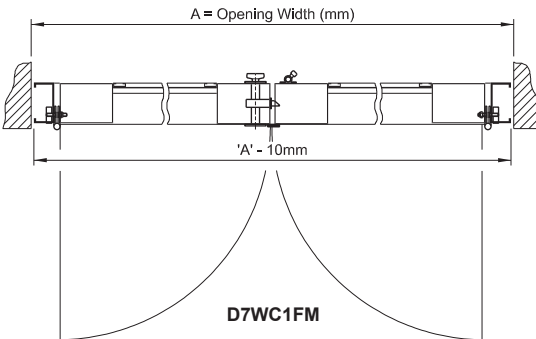
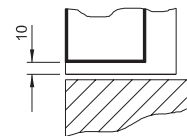

D7WC1FM

Single Leaf Louvres Doors

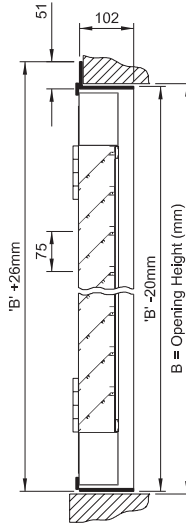
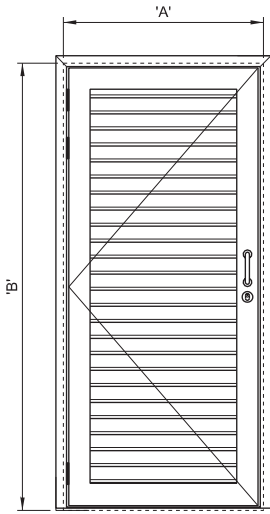

S7WA1FM

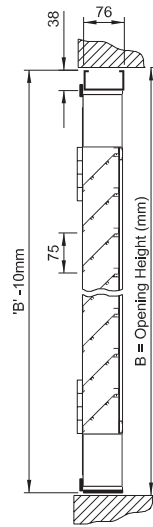

S7WC1FM

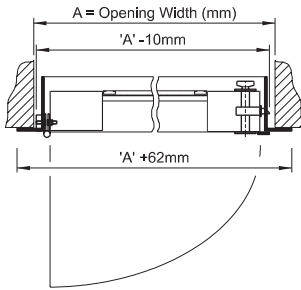

S7WA1FM

Recommended Fixing Options

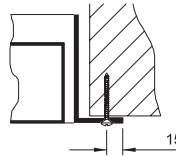

Frame A1 '+1' Fixings
Pre-drilled $\varnothing 4.5$ mm countersunk holes in flanges to suit No.8 screws. Hole centers at factories discretion, or to suit specific requirements.

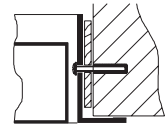

Frame A1 '+0' Fixings
Fixings through frame into surrounding structure by others. Frame should be packed out with suitable shims at fixing points to avoid distortion.

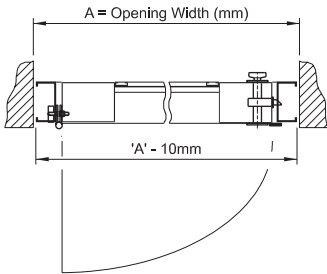

S7WA1FM



Frame C1 '+0' Fixings
Fixings through frame into surrounding structure by others. Frame should be packed out with suitable shims at fixing points to avoid distortion.

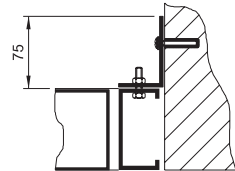

Frame C1 '+2' Fixings
Fixings via rear angle lugs bolted to rear of frame. Lugs are supplied loose for site fixing. Lugs are complete with slotted holes to suit M6 fixings. Frame drillings and M6 fixings by others.